

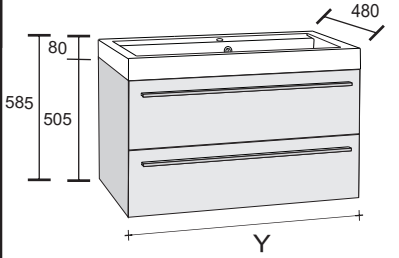

## BOLOGNA 1 Tap hole 1 Cabinet

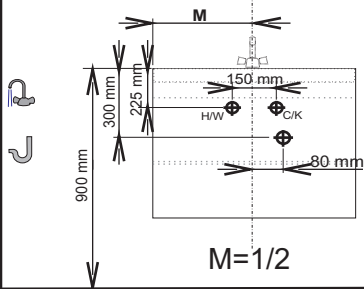

Y = 600mm/800mm/1000mm



## 2 Tap holes 1 Cabinet

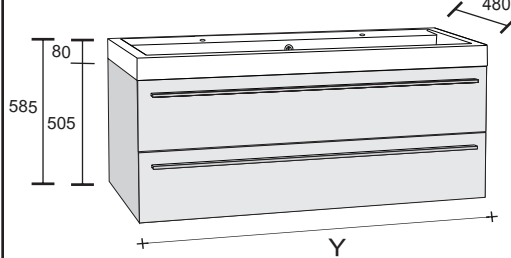

Y = 1000mm/1200mm/1400mm

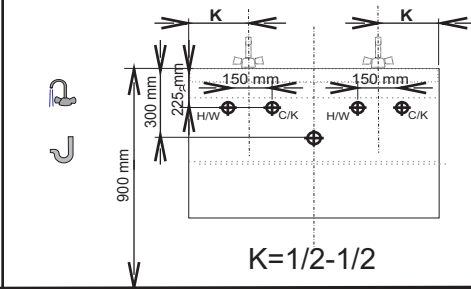

## 2 Tap holes 2 Cabinets

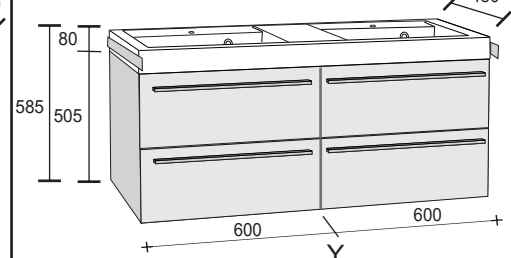

Y = 2x600mm

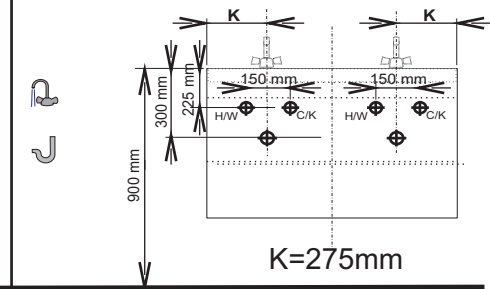

## BOLOGNA 2 Tap holes 1 Cabinets

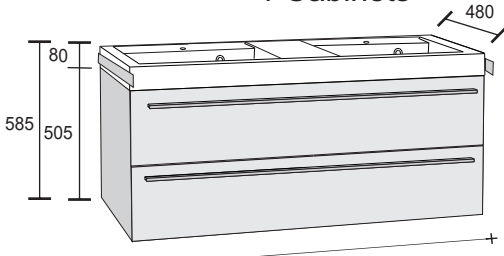

Y = 1200mm/1400mm

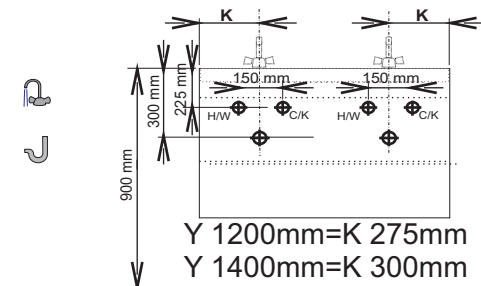

## 1 Tap hole 1 Cabinet

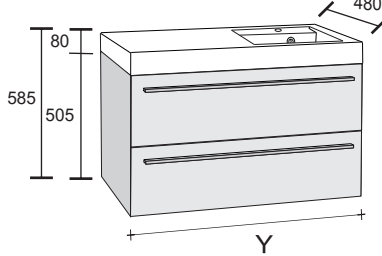

Y = 1000mm

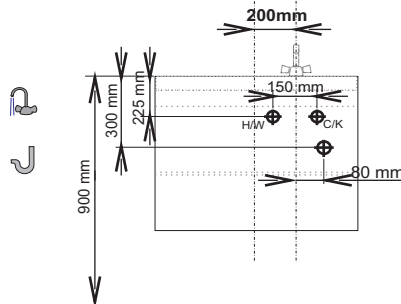

## 1 Tap hole 1 Cabinet

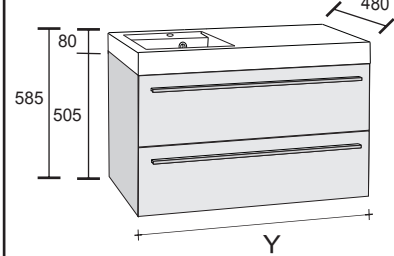

Y = 1000mm

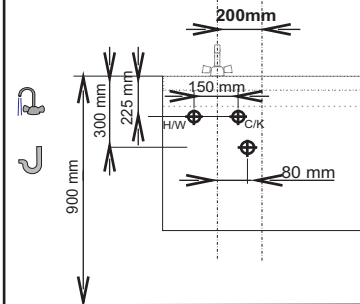

## BRONI 1 Tap hole 1 Cabinet

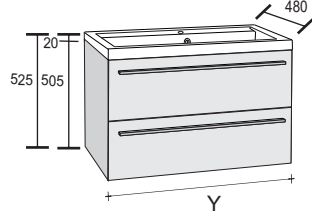

Y = 600mm/800mm/1000mm

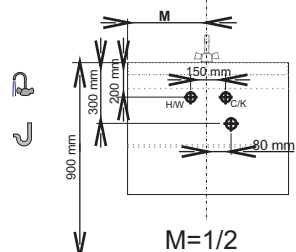

## 2 Tap holes 1 Cabinet

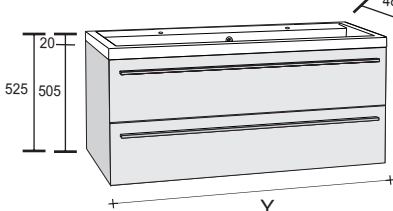

Y = 1000mm/1200mm/1400mm

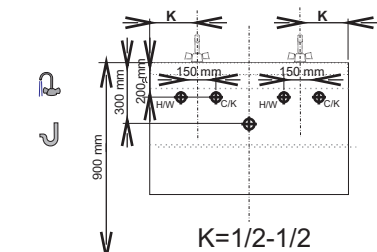

## 2 Tap holes 2 Cabinets

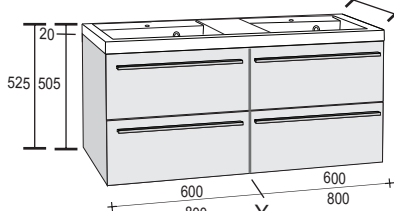

Y = 2x600mm/2x800mm

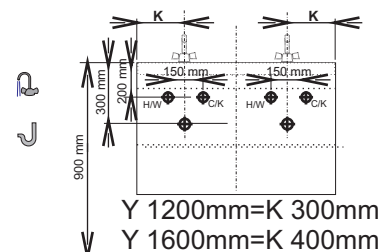

## 2 Tap holes 1 Cabinet

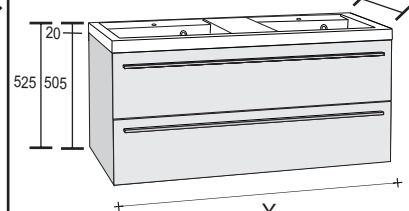

Y = 1200mm/1400mm

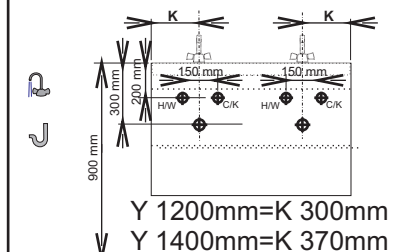

	X
BOLOGNA	644mm
BRONI	704mm

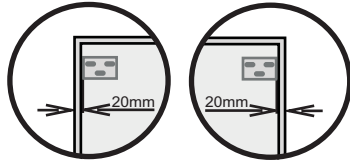

## 2 DRAWERS

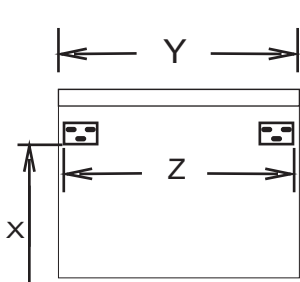

Y	Z
600	560
800	760
1000	960
1200	1160
1400	1360

## 4 DRAWERS

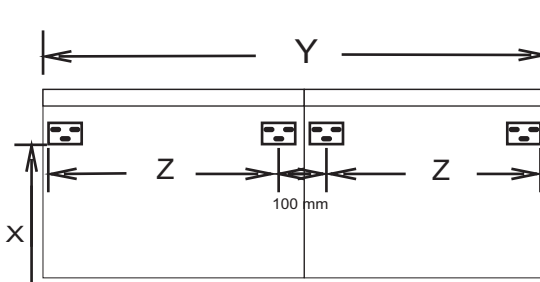

Y	Z
1200	530
1600	730

